

WHELEN[®] ENGINEERING COMPANY INC.

51 Winthrop Road
 Chester, Connecticut 06412-0684
 Phone: (860) 526-9504
 Fax: (860) 526-4078
 Internet: www.whelen.com
 Sales e-mail: autosale@whelen.com
 Canadian Sales e-mail: autocan@whelen.com
 Customer Service e-mail: custserv@whelen.com

Installation Guide:
Siren Model(s)
295SLSA1 (200W / 12V)
295SLSC1 (200W / 12V / Removable Mic)
295SLSE1 (200W / 24V)

DANGER! Sirens produce extremely loud emergency warning tones! Exposure to these tones without proper and adequate hearing protection, could cause ear damage and/or hearing loss! The Occupational Safety & Health Administration (www.osha.gov) provides information necessary to determine safe exposure times in Occupational Noise Exposure Section 1910.95. Until you have determined the safe exposure times for your specific application, operators and anyone else in the immediate vicinity should be required to wear an approved hearing protection device. **FAILURE TO FOLLOW THIS RECOMMENDATION COULD CAUSE HEARING LOSS!**

Safety First

This document provides all the necessary information to allow your Whelen product to be properly and safely installed. Before beginning the installation and/or operation of your new product, the installation technician and operator must read this manual completely. Important information is contained herein that could prevent serious injury or damage.

- Proper installation of this product requires the installer to have a good understanding of automotive electronics, systems and procedures.
- If mounting this product requires drilling holes, the installer **MUST** be sure that no vehicle components or other vital parts could be damaged by the drilling process. Check both sides of the mounting surface before drilling begins. Also de-burr any holes and remove any metal shards or remnants. Install grommets into all wire passage holes.
- If this manual states that this product may be mounted with suction cups, magnets, tape or Velcro®, clean the mounting surface with a 50/50 mix of isopropyl alcohol and water and dry thoroughly.
- Do not install this product or route any wires in the deployment area of your air bag. Equipment mounted or located in the air bag deployment area will damage or reduce the effectiveness of the air bag, or become a projectile that could cause serious personal injury or death. Refer to your vehicle owner's manual for the air bag deployment area. The User/Installer assumes full responsibility to determine proper mounting location, based on providing ultimate safety to all passengers inside the vehicle.
- For this product to operate at optimum efficiency, a good electrical connection to chassis ground must be made. The recommended procedure requires the product ground wire to be connected directly to the **NEGATIVE (-)** battery post.
- If this product uses a remote device to activate or control this product, make sure this control is located in an area that allows both the vehicle and the control to be operated safely in any driving condition. **DO NOT ATTEMPT TO ACTIVATE OR CONTROL THIS DEVICE IN A HAZARDOUS DRIVING SITUATION.**
- It is recommended that these instructions be stored in a safe place and referred to when performing maintenance and/or reinstallation of this product.
- **FAILURE TO FOLLOW THESE SAFETY PRECAUTIONS AND INSTRUCTIONS COULD RESULT IN DAMAGE TO THE PRODUCT OR VEHICLE AND/OR SERIOUS INJURY TO YOU AND YOUR PASSENGERS!**

ACTIVATION OF THIS SIREN MAY DAMAGE UNPROTECTED EARS!



Wear Protection!

CAUTION

Loud siren noise can cause hearing damage and/or loss. Refer to OSHA Section 1910.95 prior to putting ANY siren into service!

For warranty information regarding this product, visit www.whelen.com/warranty

Congratulations on selecting the 295SLS Series Siren. This series offers a unique and distinctive collection of features designed to allow the user to customize the operation of this siren to suit their individual wants or needs.

- Power to drive two, 100-Watt speakers
- Scan-Lock™ Tone Programing
- Hands-Free operation.
- Siren Interruption Control
- High and Low Voltage Shutdown
- Radio Repeat
- Auxiliary Input Control
- Horn Ring Transfer
- Simulated mechanical siren tones
- Speaker Diagnostics
- “Siren In Use” Output
- LED Backlighting
- Harmonically-rich, composite Airhorn tones
- Title 13-compliant profiles
- Compact Size
- Non-destructive Short Circuit Protection
- Meets Class A Sound Requirements
- External Backlight Control

Mounting

The 295SLS is designed to be mounted directly onto the dash or other surface through the use of a bail strap mounting bracket. The unit may also be mounted into your vehicle’s console (if so equipped). **Regardless of the style selected, be sure to observe the air bag warning on the cover of this manual.**

Bail Strap Mount

1. Position the bail strap in the selected mounting location. Using an awl or other suitable tool, scribe the surface where the mounting holes are to be drilled.

Caution: As mounting this unit will require drilling, it is absolutely necessary to make sure that no other vehicle components could be damaged in the process. Check both sides of the mounting surface before starting. If damage is likely, select a different mounting location.

2. Drill the mounting holes in the areas scribed in step 1. The size of the drill bit should be determined by the size of the mounting hardware used and thickness of the mounting surface.
3. Secure the bail strap to the mounting location.

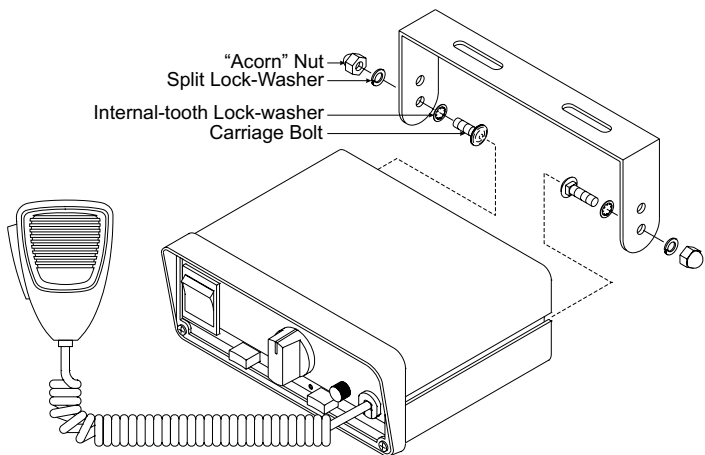

Note: There are 2 sets of holes on the Bail Strap for positioning the unit at 2 different heights.

4. Secure the siren to the bail bracket using the provided hardware as shown below.
5. Tighten the Acorn nut firmly.

Console Mount

Console manufacturers offer mounting kits that include all the necessary hardware and brackets required to mount this unit into their console. The console mount brackets are secured onto the unit the same way the bail bracket is (except for the addition of two flat washers that must be inserted between the siren and the bracket). Please refer to the manual included with your console for specific information on securing the siren/mounting bracket assembly onto the console.

NOTE: Due to the lack of air flow within a console, prolonged operation of this siren may require the console to be modified to improve ventilation.

Microphone Clip

A microphone clip is included with this product. The installer must refer to the Air Bag Warning below before installing this clip.

IMPORTANT AIR BAG WARNING! Do not install this product or route any wires in the air bag deployment zone of your vehicle. Equipment mounted or located in air bag deployment zones will damage or reduce the effectiveness of the air bag, or become a projectile that could cause serious personal injury or death. Refer to your vehicle owners manual to learn the air bag deployment zones for the vehicle. The User/Installer assumes full responsibility to determine proper mounting location, based on providing ultimate safety to all passengers inside the vehicle.

Wiring:

Power & Ground Wires: **RED: Power / BLACK: Ground**

WARNING! All customer supplied wires that connect to the positive terminal of the battery must be sized to supply at least 125% of the maximum operating current and FUSED at the battery to carry that load. DO NOT USE CIRCUIT BREAKERS WITH THIS PRODUCT!

1. Splice the 2 RED (Power) wires together, then extend this single RED wire toward the vehicle battery. Splice the 2 BLACK (Ground) wires together and extend this single BLACK wire toward the vehicle battery. To pass the RED and BLACK wires through, you may have to drill a hole in the firewall. Be sure there are no components that could be damaged. Insert a grommet in the hole to protect the wires.
2. Route the RED and BLACK wires along the factory harness towards the battery and install a fuse block (user supplied) on the end of the RED wire (refer to the wiring schematic on page 4 for your model's fuse value). **NOTE:** Remove the fuse from the fuse block before connecting any wires to the battery.
3. Connect the fuse block wire to the POSITIVE (+) terminal on the battery. There must not be more than 2 feet of wire between fuse block and battery. The wire between the fuse and the battery is "unprotected," don't allow it to contact with any wires.
4. Connect the BLACK wire to the factory chassis ground.

Speaker Wires: **ORANGE, YELLOW & BROWN**

1. Route the ORANGE, YELLOW and BROWN wires toward the vehicle siren speakers, along the factory wire harness and through the firewall at the same point as the RED and BLACK wires.
2. Connect the YELLOW and ORANGE wires to the POSITIVE connection on speakers #1 & 2 (respectively).
3. Connect the BROWN wire to the NEGATIVE connection on speakers #1 & 2.

Horn Relay Wires: **WHITE & GREY**

1. Route the WHITE and GREY wires along the factory wire harness and through the firewall at the same point as the RED and BLACK wires.
2. Route the WHITE and GREY wires to your vehicle's horn relay. If possible, follow the factory wire harness to this relay.
3. Locate the wire that connects the vehicle horn to the horn relay and cut it.
4. Connect the WHITE wire to the wire coming from the horn relay.
5. Connect the GREY wire to the wire coming from the horn.

Radio Rebroadcast (optional): **2 BLUE wires**

The two remaining BLUE wires are used to connect your two-way radio's external speaker for radio rebroadcast (an optional connection).

NOTE: If your remote speaker is amplified (has a power amp circuit in the speaker), radio rebroadcast will not work and should not be enabled.

1. Locate the two wires that connect the external speaker to the two-way radio, cut one of them and splice one of the BLUE wires into this circuit.
2. Now cut the remaining speaker wire and splice the remaining BLUE wire into this circuit.

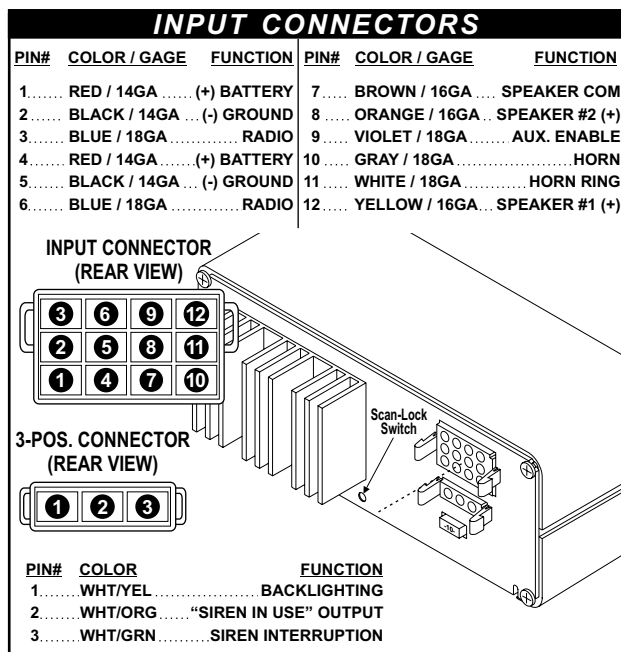

Connecting to a Remote Control-Head: (Optional)

This unit may be connected to an existing control head, such as the Whelen PCCS9NP or equivalent. This is an optional connection that enables the WAIL tone to be activated through the use of a PCCS9NP button or switch. If this connection is not chosen, cut the VIOLET wire and cap it to prevent accidental grounding of the wire.

OPERATING THE CONTROLS:

Power Switch

This switch has two positions: Down (Off) and Up (On). When this switch is Off, the unit will not function. When the switch is On, the siren is functional and may be activated at the operator's discretion. This switch also activates control head backlighting. **NOTE:** If the unit is connected to the vehicle's horn ring circuit, the vehicle horn is disabled when the power switch is in the ON position.

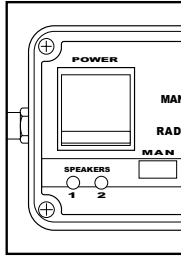

MAN Button

The Manual button generates a variety of tones, depending on what position the rotary knob is in. For further explanation of this button's function, refer to "Rotary Switch Operations."

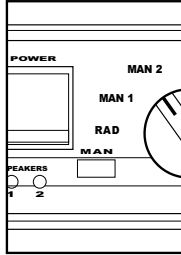

PA Volume (MIC)

With the vehicle in an enclosed area, turn the siren on and speak into the microphone. While speaking, turn knob clockwise to increase the volume. Continue to increase the PA volume until audio feedback occurs. Turn counter-clockwise to eliminate feedback.

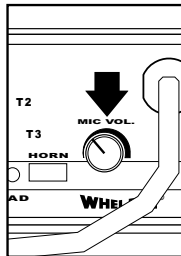

Horn Button

Holding the HORN button on generates a AIRHORN tone when the siren is powered up.

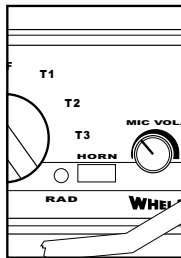

Rotary Switch

The Rotary Knob controls the siren functions. There are 7 positions that may be selected. Each position and its function is outlined under "Rotary Switch Operations."

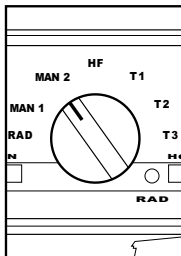

WIRING DIAGRAM

NOTE: All Fuses & Fuse Blocks are to be supplied by the Customer. Do **NOT** use circuit breakers with this product!

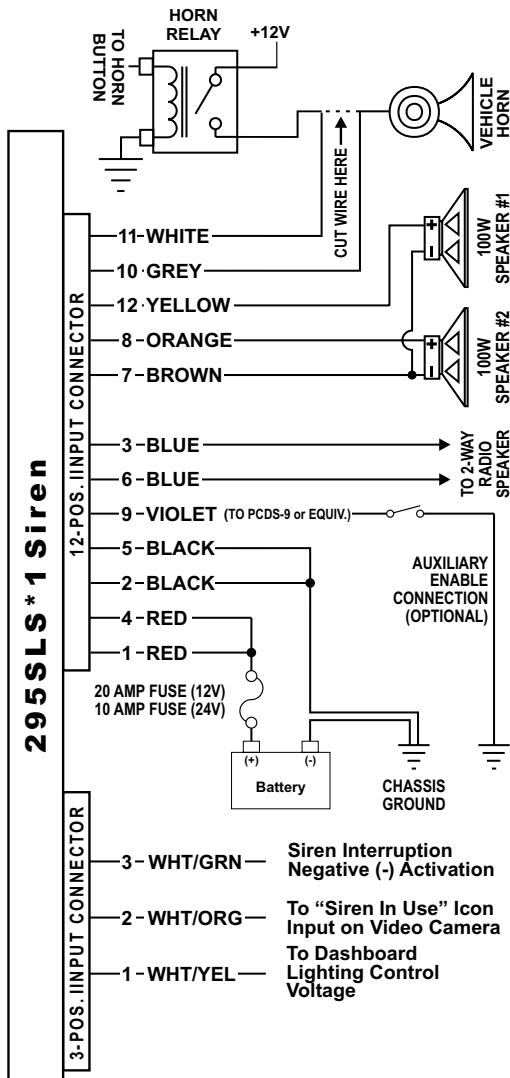

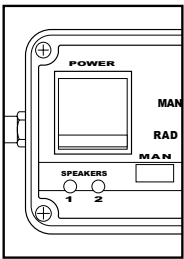

SI TEST® & Diagnostic Indicators

SI TEST® is a diagnostic feature and allows the operator to confirm the proper operation of the siren speakers connected to the unit without activating an audible siren tone. To initiate the SI TEST® cycle, set the rotary knob to the RAD position. Now press and release the MAN button. As the siren is tested, its diagnostic indicator will turn on steady for about 1.5 seconds if no problems are detected. If the indicator flashes or does not light at all, a problem with either the siren, speakers or wiring has been detected. Check the wire connections of the failed speaker and repeat the SI TEST®. If the speaker fails again, have the siren inspected by a qualified technician. **WARNING:** Installed speakers are tested by generating a ultra-high frequency tone through each speaker. Although these tones are inaudible to humans, be sure there is nobody within 5 feet of the speakers when SI TEST® is running.

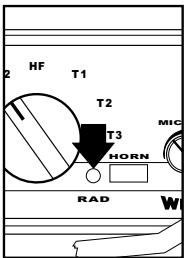

Radio Repeat Volume (RAD)

Locate the Radio Repeat adjustment port as shown. Set the volume level of the vehicle's two-way radio to it's normal operating volume. Turn the Rotary Knob to RAD to activate Radio Repeat. Insert the screwdriver in the Radio Repeat adjustment port and turn clockwise to increase the volume.

Diagnostic Indicators:

This unit has two diagnostic indicators on the front panel which are used to indicate fault conditions with your siren system. The following table lists the type of fault and the indicators response. If the indicator is on steady while a tone is in use, this implies that there is no fault with the associated speaker output.

Fault Condition	Diagnostic Indicators Response
Under Voltage	Speaker LED #1 will be in a DoubleFlash mode (2 quick flashes followed by a longer pause) and the siren tones will not operate.
Over Voltage	Speaker LED #2 will be in a DoubleFlash mode (2 quick flashes followed by a longer pause) and the siren tones will not operate.
Speaker #1 Short Circuit	Speaker LED # 1 will be in a SingleFlash mode (the LED will be on and off an equal amount of time) and the siren tones will not operate.
Speaker #2 Short Circuit	Speaker LED #2 will be in a SingleFlash mode (the LED will be on and off an equal amount of time) and the siren tones will not operate.
Speaker #1 Open Circuit	Speaker LED #1 will be off (having a single speaker system will always cause this condition for the speaker output not in use) all tones will continue to operate.
Speaker #2 Open Circuit	Speaker LED #2 will be off (having a single speaker system will always cause this condition for the speaker output not in use) all tones will continue to operate.

Rotary Switch Operations

This section will outline the operation of the siren in the **factory default configuration**. Refer to the Scan-Lock™ section on the following page for information and procedures on how to customize the operation of this siren.

RAD (Radio Repeat) - When the rotary knob is in the RAD position, any signal that is received by the vehicle's two-way radio will be simultaneously broadcast over the vehicle's loudspeaker (the unit must be connected to the two-way radio as outlined in this manual).

With the Rotary Switch in this Position:

- Activating the HORN button will produce the AIRHORN tone until released.
- Pressing the MAN button will start SI TEST® as described on Page 5.
- Activating the HORN RING input will produce the AIRHORN tone until the MAN switch is released.
- Activating the AUX ENABLE input has no effect.

MAN 1 (Manual Siren #1) - When the rotary switch is in this position the siren is in a standby state where no tones have been activated, but is waiting for another action to be taken by the operator.

With the Rotary Switch in this Position:

- Activating the HORN button will produce the AIRHORN tone until released.
- Pressing the MAN button will produce the AIRHORN tone until the MAN switch is released.
- Activating the HORN RING input will produce the AIRHORN tone until the HORN RING input is released.
- Activating the AUX enable input will produce a repeating WAIL tone.

MAN 2 (Manual Siren #2) - When the rotary switch is in this position the siren is in a standby state. No tones will be activated until another action is taken by the operator.

With the Rotary Switch in this Position:

- Activating the HORN button will produce the AIRHORN tone until released.
- Pressing the MAN switch will produce a WAIL tone. This tone will ramp up to peak frequency and stop when the MAN switch is released.
- Activating the HORN RING input will produce a WAIL tone. This tone will ramp up to peak frequency and stop when the HORN RING input is released.
- Activating the AUX enable input will produce a repeating WAIL tone.

HF (Hands-Free Operation) - When the rotary knob is in the HF position, the siren functions are placed in a standby mode. Siren tones are activated by a single "tap" on the MAN button or on the vehicle's steering wheel horn ring (if the vehicle's horn has been

wired to the HORN RING input). The first tap produces a "Wail" tone (a steady rise and fall tone). A second tap produces a "Yelp" tone (a fast rise and fall tone). A third tap produces a piercer tone (an extremely fast rise and fall tone). The next tap returns the siren to a wail tone and the cycle repeats itself. Two quick successive taps will stop the siren.

With the Rotary Switch in this Position:

- Activating the HORN button will produce the AIRHORN tone until released.
- Pressing the MAN button will produce the HF cycle as described above.
- Activating the HORN RING input will produce the HF cycle as described above.
- Activating the AUX ENABLE input will start the HF cycle. Releasing the AUX ENABLE will stop the cycle.

T1 (Tone #1) - When the rotary knob is in the T1 position, a steady, rise and fall tone (WAIL) is produced.

With the Rotary Switch in this Position:

- Activating the HORN button will produce the AIRHORN tone until released.
- Pressing the MAN button will change the siren tone to a yelp pattern (a fast rise and fall tone). Pressing the MAN button a second time returns it back to WAIL.
- Activating the HORN RING input will change the siren tone to YELP. Activating the HORN RING input again to return to a WAIL tone.
- Activating the AUX ENABLE input has no effect.

T2 (Tone #2) - When the rotary knob is in the T2 position, a fast, rise and fall tone (YELP) is produced.

With the Rotary Switch in this Position:

- Activating the HORN button will produce the AIRHORN tone until released.
- Pressing the MAN button will produce the PIERCER tone. Pressing the MAN switch a second time returns it back to YELP.
- Activating the HORN RING input will produce the AIRHORN tone until the HORN RING input is released.
- Activating the AUX ENABLE input has no effect.

T3 (Tone #3) - When the rotary knob is in the T3 position, an extremely fast, rise and fall tone is produced.

With the Rotary Switch in this Position:

- Activating the HORN button will produce the AIRHORN tone until released.
- Pressing the MAN button will result in the AIRHORN tone until the MAN button is released.
- Pressing the HORN RING input will result in the AIRHORN tone until the HORN RING input is released.
- Activating the AUX ENABLE will have no effect.

	<u>12-Volt Models</u>	<u>24-Volt Models</u>
INPUT VOLTAGE	12 VDC ±20%	24 VDC ±20%
INPUT CURRENT	16 AMPS (TYP.)	8 AMPS (TYP.)
INPUT FUSE	20 AMPS	10 AMPS
SPEAKER IMPEDANCE	11 OHMS MIN.	11 OHMS MIN.
OPERATING TEMPERATURE	-30° C. TO +80° C.	-30° C. TO +80° C.
STORAGE TEMPERATURE	-40° C. TO +70° C.	-40° C. TO +70° C.
HUMIDITY	99% (Non-Condensing)	99% (Non-Condensing)

ACTIVATION OF THIS SIREN MAY DAMAGE UNPROTECTED EARS!



Wear Protection!

CAUTION

Loud siren noise can cause hearing damage and/or loss. Refer to OSHA Section 1910.95 prior to putting ANY siren into service!

Scan-Lock™ Programing Procedures

With Scan-Lock, the tonal operation of the siren can be customized to fit the users needs. A momentary switch, accessed through a small hole on the back of the siren, is used to change the default siren tones as outlined below. A non-conductive tool (such as the tip of a pen) should be used to actuate this switch.

To change the primary tone for rotary switch positions T1, T2, and T3: Put the rotary switch in the position that you wish to change. Press and release the Scan-Lock switch. Each time the Scan-Lock switch is pressed and released, the next available tone will be broadcast (see "Tone List For Rotary Switch Positions T1, T2 & T3"). When the desired tone is generated, it will automatically be saved for that rotary switch position.

To change the override tone for rotary switch positions T1, T2, and T3: Put the rotary switch in the position that you wish to change. Press and hold the MAN button on the front panel on the siren. Press and release the Scan-Lock switch. Each time the Scan-Lock switch is pressed and released, the next available tone will be broadcast (see "Override Tone List For Rotary Switch Positions T1, T2 & T3"). When the desired tone is present, it will automatically be saved as the override tone for that rotary switch position. Release the MAN button.

To change one of the tones in the hands free cycle as described in the "Rotary Switch Operations" section of this manual: Put the rotary switch in the HF position. Using the MAN button on the front panel on the siren, advance to the tone that you wish to change. Press and release the Scan-Lock switch. Each time the Scan-Lock switch is pressed and released, the next available tone will be broadcast (see "Tone List For Hands Free Operation"). When the desired tone is generated, it will automatically be saved for that hands-free cycle position.

To change the tone for rotary switch positions MAN1 or MAN2: Put the rotary switch in the position that you wish to change. Press and hold the MAN button on the front panel on the siren. Press and release the Scan-Lock switch. Each time the Scan-Lock switch is pressed and released, the next available tone will be broadcast (see "Tone List For MAN1 & MAN2 Operation"). When the desired tone is generated, it will automatically be saved for that rotary switch position. Release the MAN button.

To change the override tone for rotary switch position RAD: Put the rotary switch in the RAD position. Press and hold the MAN button on the front panel on the siren. Press and release the Scan-Lock switch. Each time the Scan-Lock switch is pressed and released, the next available tone will be broadcast (see "Override Tone List For RADIO Rotary Switch Position"). When the desired tone is generated, it will automatically be saved for that rotary switch position. Release the MAN button.

To change the tone for the HORN button: Put the rotary switch in the MAN2 position. Press and hold the HORN button on the front panel of the siren. Press and release the Scan-Lock switch. Each time the Scan-Lock button is pressed and released, the next available tone will be broadcast (see "Tone List for HORN Button"). When the desired tone is generated, it is automatically saved for HORN Button activation.

To Enable Title 13 Operation Mode - Place the Rotary Switch into a stand-by position (MAN1, MAN2, HF) and turn the unit OFF. While holding *both* the Scan-Lock™ switch and the MAN button down, turn the unit ON. A set of Title 13-compliant tones are now available. *Note that AIRHORN is not allowed to override the primary warning tones while in this mode.*

Siren Interruption Configuration - The siren interruption feature can be configured to operate in 2 modes:

PAUSE: Grounding the WHT/GRN wire will deactivate the siren and removing ground from the WHT/GRN wire will reactivate the siren. **CANCEL:** (Factory default) Grounding the WHT/GRN wire will deactivate the siren, however, removing ground from the WHT/GRN wire will not reactivate the siren. The operator must reset the siren by placing the rotary switch into one of the standby positions (HF, MAN1 or MAN2).

To change the siren interruption mode - Place the rotary switch into a standby position (HF, MAN1 or MAN2) and turn the unit OFF. While holding both the Scan-Lock and AIRHORN button in turn the power switch on.

To Restore the Factory Default Configuration - Place the Rotary Switch into a stand-by position (MAN1, MAN2, HF) and turn the unit OFF. While holding the Scan-Lock switch down, turn the unit ON. The factory default configuration is now restored.

Tone List For Rotary Switch Positions T1, T2 & T3:

TONE OFF	HI/LOW	ALTERNATE WAIL*
WAIL*	SIMULATED	ALTERNATE YELP*
YELP*	MECHANICAL	WOOP
PIERCER	PULSED AIRHORN	WARBLE
Y-249*	AIRHORN HI/LOW	

* California Title 13-Compliant Siren Tones.

Tone List For Hands Free Operation:

WAIL	SIMULATED	ALTERNATE YELP
YELP	MECHANICAL	WOOP
PIERCER	PULSED AIRHORN	WARBLE
Y-249	AIRHORN HI/LOW	
HI/LOW	ALTERNATE WAIL	

Tone List For HORN Button:

TONE OFF
AIRHORN COMMAND CODE
AIRHORN LOW COMMAND CODE

Override Tone List For Rotary Switch Positions T1, T2 & T3:

TONE OFF	SIMULATED	WOOP
WAIL	MECHANICAL	WARBLE
YELP	PULSED AIRHORN	AIRHORN
PIERCER	AIRHORN HI/LOW	LOW FREQ. AIRHORN
Y-249	ALTERNATE WAIL	
HI/LOW	ALTERNATE YELP	

Tone List For MAN1 & MAN2 Operation:

TONE OFF
MANUAL SIMULATED MECHANICAL COAST-TO-STOP
MANUAL SIMULATED MECHANICAL STOP
MANUAL WAIL COAST-TO-STOP
MANUAL WAIL STOP
AIRHORN
LOW FREQ. AIRHORN

Override Tone List For Rotary Switch Position Radio:

TONE OFF	AIRHORN LOW COMMAND CODE
AIRHORN COMMAND CODE	CODE

Wire Gauge Calculation Chart

		Wire Gauge (AWG)										
		22	20	18	16	14	12	10	8	6	4	2
Current Draw (AMPS)	5	6	9.5	15	24.5	39	62	98	156	248	395	629
	10	3	5	7.5	12	19.5	31	49	78	124	197	314
	15	INS.	3	5	8	13	20.5	32.5	52	82.5	131	209
	20	INS.	INS.	4	6	9.5	15.5	24.5	39	62	98.5	157
	25	INS.	INS.	3	5	8	12.5	19.5	31	49.5	79	125
	30	INS.	INS.	INS.	4	6.5	10.5	16.5	26	41.5	66	104
	35	INS.	INS.	INS.	3.5	5.5	9	14	22.5	35.5	56.5	89.5
	40	INS.	INS.	INS.	3	5	7.5	12.5	19.5	31	49.5	78.5
	45	INS.	INS.	INS.	INS.	4.5	7	11	17.5	27.5	44	69.5
	50	INS.	INS.	INS.	INS.	4	6	10	15.5	25	39.5	63
	55	INS.	INS.	INS.	INS.	3.5	5.5	9	14	22.5	36	57
	60	INS.	INS.	INS.	INS.	3	5	8	13	20.5	33	52.5
	65	INS.	INS.	INS.	INS.	3	5	7.5	12	19	30.5	48.5
	70	INS.	INS.	INS.	INS.	3	4.5	7	11	17.5	28	45
	75	INS.	INS.	INS.	INS.	INS.	4	6.5	10.5	16.5	26.5	42
	80	INS.	INS.	INS.	INS.	INS.	4	6	10	15.5	24.5	39
	85	INS.	INS.	INS.	INS.	INS.	3.5	6	9	14.5	23	37
90	INS.	INS.	INS.	INS.	INS.	3.5	5.5	8.5	14	22	35	
95	INS.	INS.	INS.	INS.	INS.	3.5	5	8	13	21	33	
100	INS.	INS.	INS.	INS.	INS.	3	5	8	12.5	19.5	31.5	

INS. = Insufficient All Distances Shown Are In Feet

To use this chart...

1. Determine the amount of current being drawn through the wire. Locate this number in the vertical left-hand column. If the current value is between adjacent values, use the higher number.

2. Follow this row until the length of the installed wire is shown. If the exact length is between adjacent values, use the higher number. Follow this column upwards to find the recommended size (gauge) for this wire.

In the example shown below, the size for a wire with an installed length of 36 feet, through which 22 amps of current will be drawn, must be determined.

A row for 22 amps is not shown, so the row for 25 amps will be used. Follow this row to the right. A column for 36 feet is not shown, so the column for 49.5 feet will be used. Following this column to the top will show that the size of this wire must be at least 6 gage.